

ECO E II HIGH



Efficient Finnish luminaire know-how. Excellent LEDs (180 lm/W) and the luminaire designed specially for the LEDs ensure the best end result in terms of long lifetime as well as efficiency. DALI control provides the comfort and energy-efficiency of smart lighting.

Benefits

Extremely energy efficient (up to 129 lm/W) high bay or low bay luminaire with low lifetime cost. Long life is ensured with carefully chosen components and superior thermal implementation. Easy and quick to install.

Suitability

General luminaire for several applications to replace high bay and low bay luminaires. Reliable, easy and energy-efficient replacement of high bay and/or low bay luminaires based on high pressure sodium, metal halide or mercury lamps. Recommended installation height: low bay luminaire 8-12m and high bay luminaire 12-20 m.

Product families and variants

PRODUCT CODE	PRODUCT FAMILY CODE	POWER	LUMINOUS FLUX	LUMINAIRE EFFICACY	LIFETIME	OPERATING TEMPERATURE
ECO E II HIGH 210 W	GL992100	210 W	27000 lm	129 lm/W	L80, F10 70 000 h	-25 - +45°C

Dimensions

PRODUCT CODE	PRODUCT FAMILY CODE	LENGTH (L)	HEIGHT (H)	WIDTH (W)	WEIGHT
ECO E II HIGH 210 W	GL992100	1480 mm	185 - 235 mm	165 - 234 mm	7,2 kg

General Description

COLOUR TEMPERATURE:	3000 K, 4000 K, 5000 K
COLOUR RENDERING INDEX:	$R_A \geq 80$
OPTIC:	Clear: Narrow, medium or wide
LIGHT SOURCE SHIELD:	PC
IP CLASS:	IP 44
SUPLY VOLTAGE:	127-277 Vac
FREQUENCY:	50-60 Hz
PF:	> 0,95
THD:	< 20%
CONNECTION:	Chainable terminal block max 5*2.5 mm ² (L,N, PE and +/- DALI) (option installation cable)
DIMMABILITY:	DALI
COLOUR:	Grey aluminium
MATERIAL OF THE LUMINAIRE BODY:	Aluminum
GUARANTEE:	5 years
ACCESSORIES (INSTALLATION):	Surface mounting, MEK rail bracket, Bracket for Horizontal Wire

Light distribution

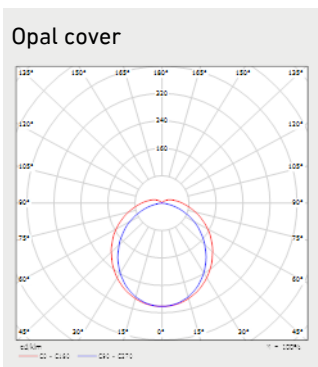
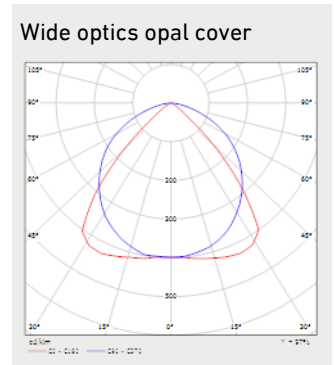
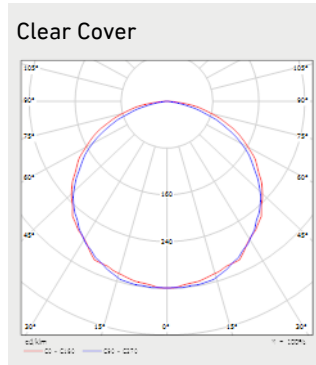
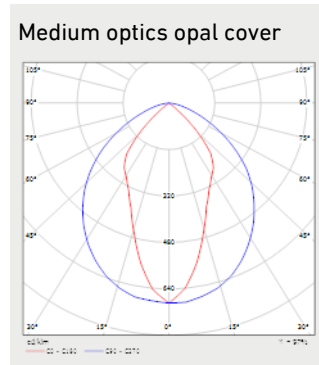
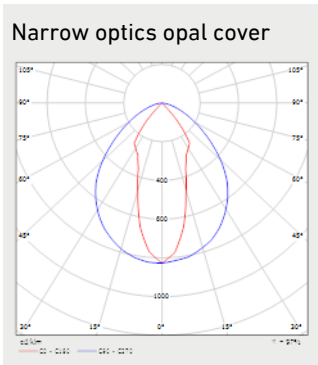

Dimensions

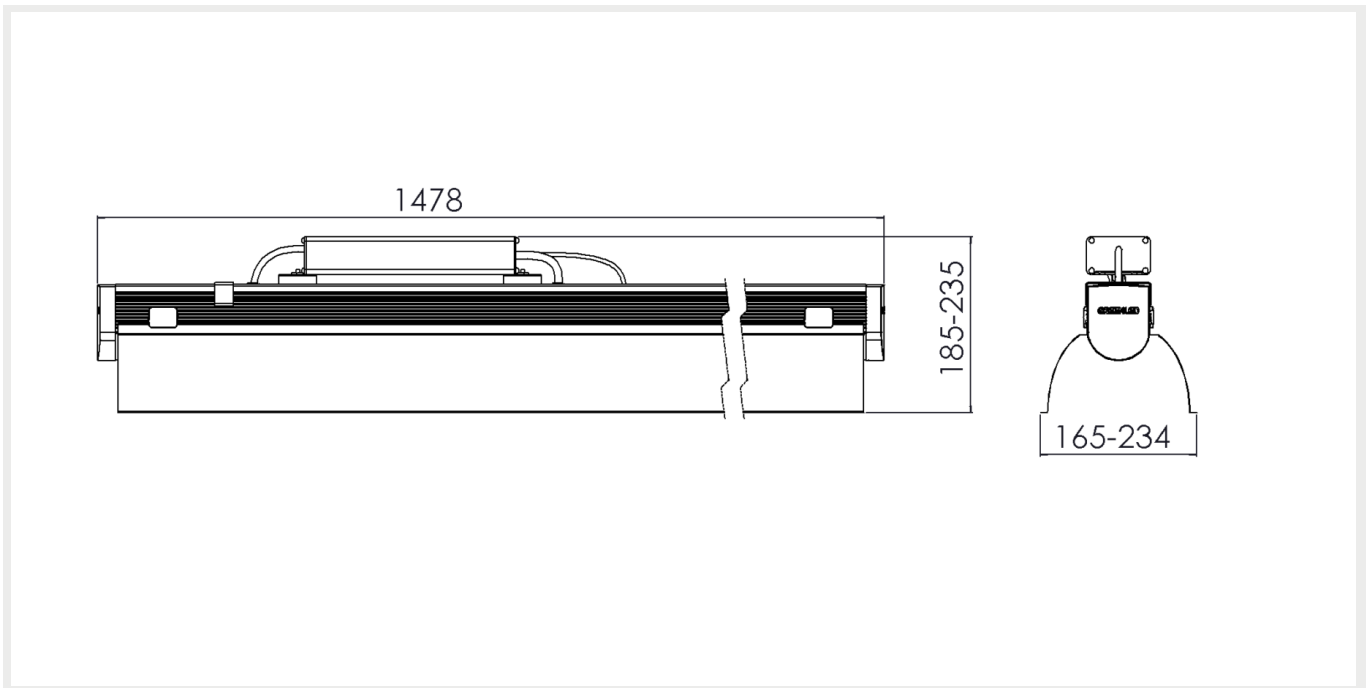

Brackets

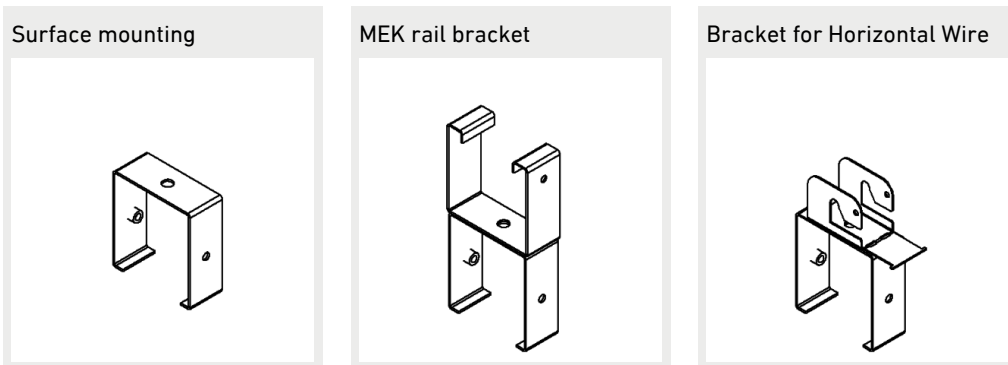

Circuit breakers

	B10	B16	B20	C10	C16	C20
ECO E II HIGH 210W	3	5	6	5	8	10

CUSTOMER SERVICE:

tel: +358 20 125 5800

info@greenled.fi